

SPECIFICATION

Item No: FD053

VER: A/0

DATE:2018/04/24

product picture:



YYC confirm:		
made:	Audit:	Approved:
liuguan 2018.04.24		
customer confirm:		
check:	Audit:	confirm:

FD053 Flood Light



1. Product features

- 1☆) With advanced High voltage linear constant current drive technology, without electrolytic capacitor, drastically reducing the components, improving the reliability and life time, the optimal cost-effective method.
- 2☆) With input under-voltage protection, input over-voltage protection, over-temperature protection, and other functions, to keep the product reliable.
- 3☆) Comply with 4 kv surge resistance level, with resistance to high and low temperature shock, applicable to outdoor harsh environment.
- 4☆) The LEDs are driven by multi-stage driving methods ,with low harmonic, constant power function .

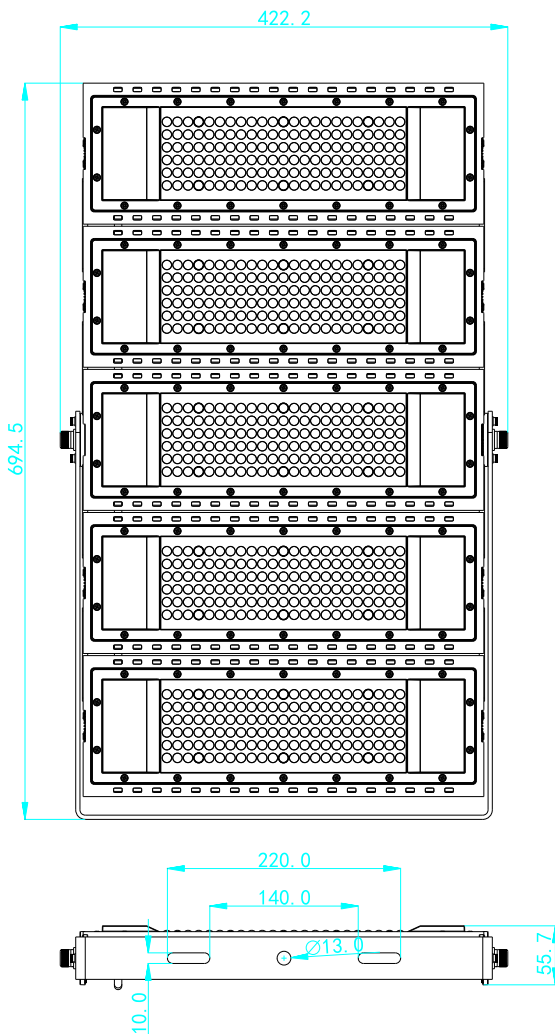

- 5☆) High power factor, high efficiency, high CRI, low degradation.
- 6☆) Beautiful, simple, unique shape, and with a number of patent protection.
- 7☆) Product is thin and light, easy to packing, shipping, install and use.

Widely used in plant lighting ,supermarket lighting, stadium lighting ,municipal project lighting, Convention Center lighting, etc.



2. specification

Item No	specification	input voltage	input power	power Factor	CCT	luminous flux	CRI	beam angle
F D053	500W	AC220V/50Hz	500W	≥0.9	WW (3000K)	47500LM	Ra70	60°/90°
F D053	500W	AC220V/50Hz	500W	≥0.9	NW (4000K)	50000LM	Ra70	60°/90°
F D053	500W	AC220V/50Hz	500W	≥0.9	PW (6000K)	52500LM	Ra70	60°/90°

NOTE:

- 1: color temperature ranges: WW (3000K±300K) NW (4000K±300K) PW (6000K±500K) .
- 2: input voltage /input power tolerance for ±10%.
- 3: luminous flux tolerance for ±10%

3. Light Characteristics

WW

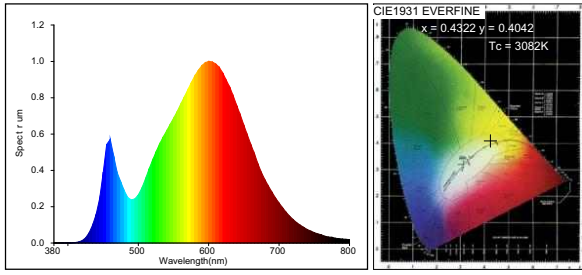

Color Parameters:

Chromaticity Coordinate: $x=0.4322$ $y=0.4042$ $u=0.2475$ $v=0.5207$
 Tc=3082K Dominant WL=Ld=582.2nm Purity=51.1% Centroid WL:590.0nm
 Ratio:R=23.8% G=73.6% B=2.6% Peak WL:Lp=600.0nm HWL:139.1nm
 Render Index:Ra=81.7
 R1 =8 0 R2 =9 0 R3 =9 7 R4 =7 7 R5 =7 9 R6 =8 6 R7 =8 4
 R8 =6 1 R9 =1 2 R10=7 6 R11=7 2 R12=6 3 R13=8 2 R14=9 8 R15=7 4

Radiation Diagram

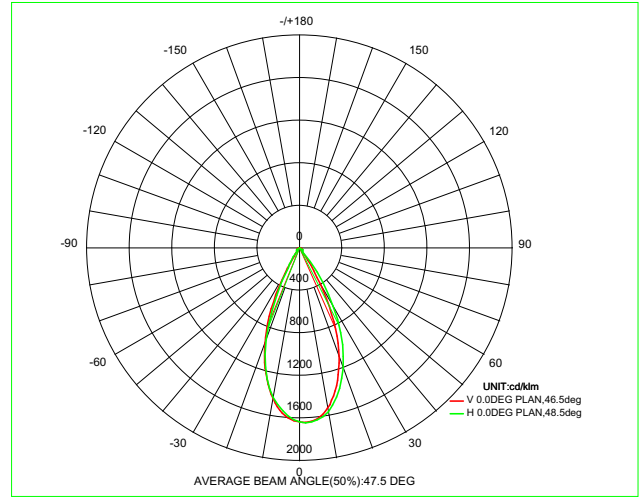

NW

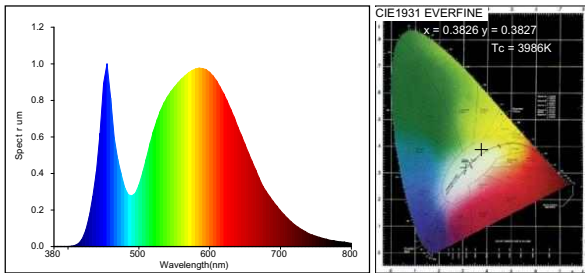

Color Parameters:

Chromaticity Coordinate: $x=0.3826$ $y=0.3827$ $u=0.2242$ $v=0.5045$
 Tc=3986K Dominant WL=Ld=578.0nm Purity=29.7% Centroid WL:573.0nm
 Ratio:R=19.2% G=77.7% B=3.1% Peak WL:Lp=455.0nm HWL:26.9nm
 Render Index:Ra=79.8
 R1 =7 8 R2 =8 6 R3 =9 1 R4 =7 7 R5 =7 6 R6 =7 9 R7 =8 7
 R8 =6 5 R9 =7 R10=6 4 R11=7 2 R12=5 1 R13=7 9 R14=9 5 R15=7 3

Lux Diagram

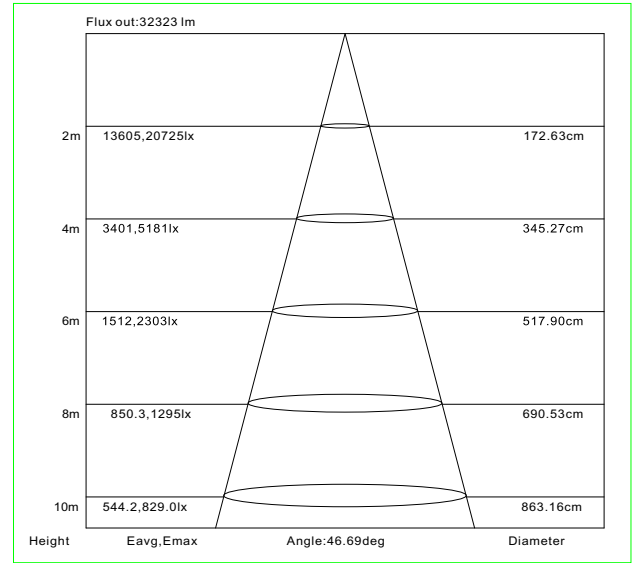

PW

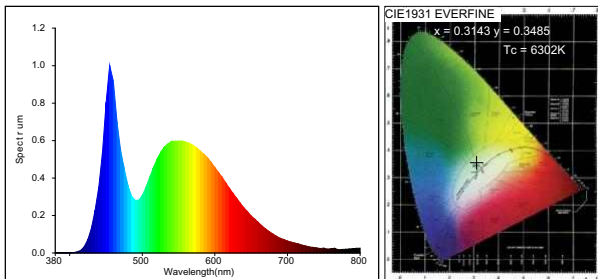

Color Parameters:

Chromaticity Coordinate: $x=0.3143$ $y=0.3485$ $u=-0.1918$ $v=0.4786$
 Tc=6302K Dominant WL=Ld=502.4nm Purity=5.8% Centroid WL:543.0nm
 Ratio:R=13.2% G=81.7% B=5.2% Peak WL:Lp=455.0nm HWL:28.4nm
 Render Index:Ra=80.6
 R1 =7 2 R2 =8 5 R3 =9 1 R4 =7 2 R5 =7 5 R6 =8 0 R7 =8 6
 R8 =6 5 R9 =2 3 R10=6 4 R11=6 7 R12=5 7 R13=7 5 R14=9 5 R15=7 0

Lighting Effects

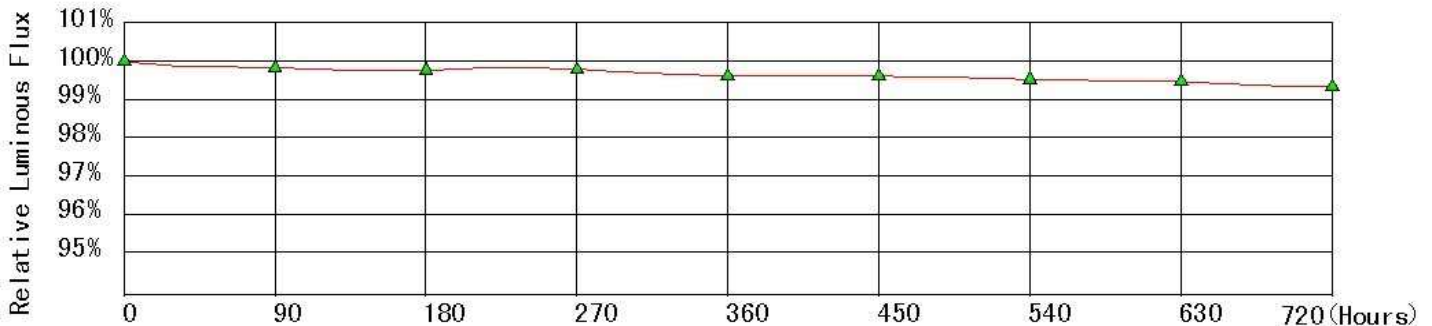

Through the 720 H accelerated agingtest, high and low temperature prediction in the rated under the working conditions after 35000 H, will provide an average 70% optic maintenance ratio (L70).

4. Installation and use

Environmental Conditions	Ambient Temp.	Storage Temp	Relative humidity	Atmosphere Pressure	Heat sink Mode	Protection degree
	-30—+45℃	-40—70℃	10—95%	70—106KPa	Natural Heat Conduction	IP66

Caution:

1. Installation and debugging must be carried out by a qualified professional.
2. When making installation, please keep at least space between the luminaries with the obstacles around, to keep good heat dissipation. It is strictly prohibited to be covered by the flammable items.
3. Supply the qualified voltage and electrical current, to ensure the luminaries work normally.
4. Ensure the earth wire safely connect to the ground, and make well processing on insulation and waterproof.

1. Adjust the angle you need, and fasten the screw by the Hex key.

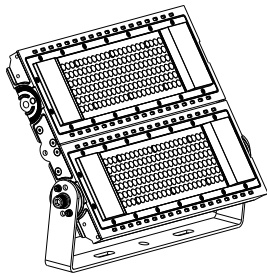

2. Install the LED floodlight onto the wall or the ground; punch hole on the wall or ground, prepare the expansion screw, and then fasten the floodlight.

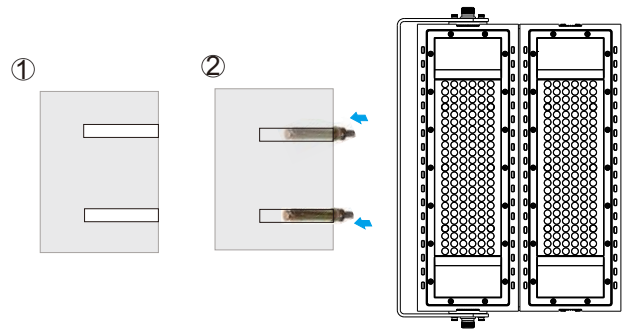

3. Connect the wire of output end on the driver with that of input end on the lighting fixture. Then do waterproof treatment for the connector. Pls note that the Brown color wire is Live wire, Blue wire is Null line.

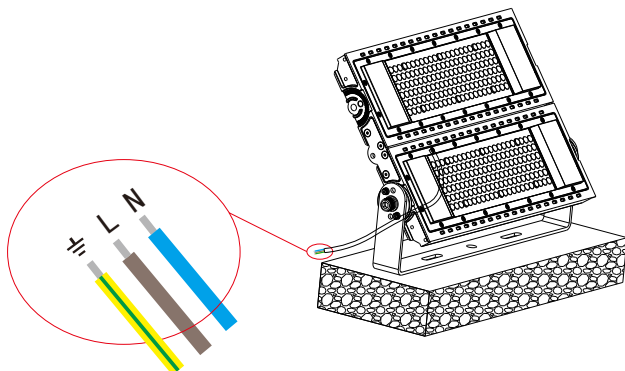

4. Turn on the power supply to ensure the light is working, Installed.

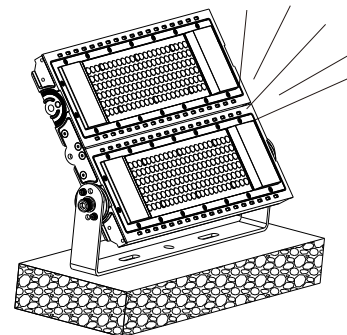

5. Packing Instructions

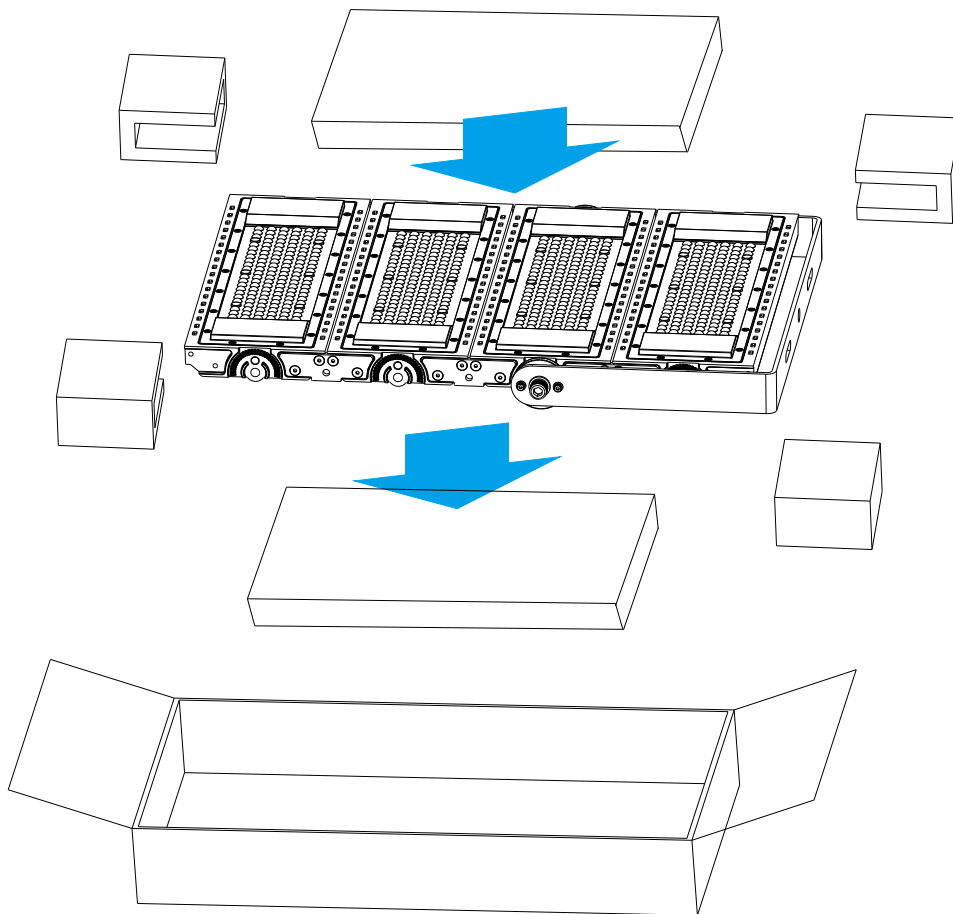

Item No	Net Weight	box			carton		
		Measurement	Gross weight	pcs/box	Measurement	Gross weight	pcs/Carton
F D053	9.2Kg				L755*W450*H115(mm)	10.5kg	1



The product specification might be subject to change without prior notice.

Tel:+86-755-81702385/81702336 Fax:+86-755-81702285 www.yyc-led.com